

Cast

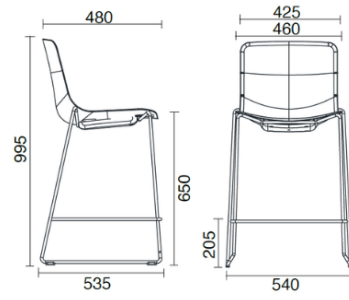

Sgabello H65



Materiali e rivestimenti

Bezug



Stoff AL - Alba / FiDiVi
Colori disponibili: 10



Stoff ME - Medley /
Gabriel
Colori disponibili: 15



Stoff MF - Main Line
Flax / Camira
Colori disponibili: 10



Stoff SY - Sinergy /
Camira
Colori disponibili: 10



Stoff RM - Remix 3 /
Kvadrat
Colori disponibili: 10



Stoff CH - Chili / Gabriel
Colori disponibili: 10



Stoff BN - Bondai /
FiDiVi
Colori disponibili: 6



Stoff AB - Xtreme Plus /
Camira
Colori disponibili: 6



Stoff FT - Foster /
Vescom
Colori disponibili: 6



Stoff S1 - Steelcut 3 /
Kvadrat
Colori disponibili: 2

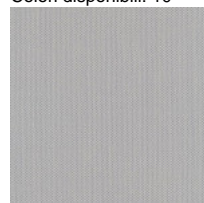

Stoff SE - Steelcut Trio 3
/ Kvadrat
Colori disponibili: 6

Questo prodotto è garantito 5 anni. Sitland si riserva di apportare modifiche e/o migliorie di carattere tecnico ed estetico ai propri modelli e prodotti in qualsiasi momento e senza preavviso. Le foto e i colori visualizzati sono puramente indicativi e possono variare rispetto alla realtà. Per maggiori informazioni si prega di contattare il nostro Servizio Clienti service@sitland.com