

Sit It



Sit.it, Design Sergio Bellin und Dorigo Design, ist eine Kollektion von Chef- und Managerstühlen mit strukturierter Linienführung, mit einem Gestell aus Stahl und Aluminium, mit diversen hochwertigen Bezügen im Angebot. Ein Klassiker für das Büro, erhältlich in den Ausführungen als Chef- und Managersessel und als Konferenz-Stühle, der dank der in unterschiedlicher Dichte gefertigten gepolsterten Kissen besten Komfort bietet. Das elegante Design der Armlehnen verbindet sich perfekt mit dem Stuhl und ist charakteristisch für die Kollektion.

Storie collegate

Orgatec, Colonia, Deutschland (2014)

Modelli

Chiefsessel

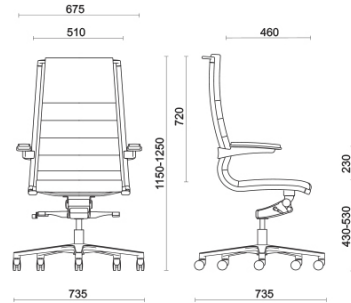

Managerstuhl

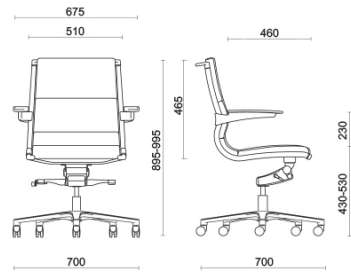

Konferenstuhl

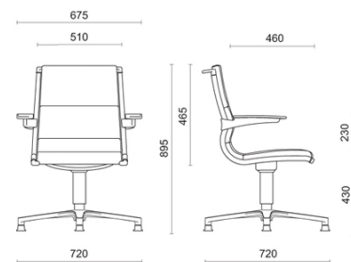

Materiali e rivestimenti

Bezug rückenlehnevorderseite (tragendes textilgewebe schwarz)



Leder TS - Florida / Dani
Colori disponibili: 5

Bezug rückenlehnevorderseite (tragendes textilgewebe weiss)

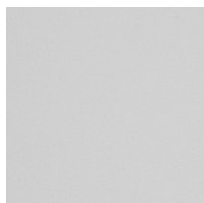

Leder TS - Florida / Dani
Colori disponibili: 1

Bezug rückenlehnevorderseite (tragendes textilgewebe braun)

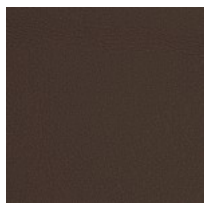

Leder TS - Florida / Dani
Colori disponibili: 3

Bezug rückenlehnevorderseite (tragendes textilgewebe taupe)



Leder TS - Florida / Dani
Colori disponibili: 1

Questo prodotto è garantito 5 anni. Sitland Spa si riserva di apportare modifiche e/o migliorie di carattere tecnico ed estetico ai propri modelli e prodotti in qualsiasi momento e senza preavviso. Le foto e i colori visualizzati sono puramente indicativi e possono variare rispetto alla realtà. Per maggiori informazioni si prega di contattare il nostro

Servizio Clienti service@sitland.com