

Cast



Sgabello H75



Materials and colours

Upholstery



Fabric AL - Alba / FiDiVi
Available colours 10



Fabric ME - Medley / Gabriel
Available colours 15



Fabric MF - Main Line Flax / Camira
Available colours 10



Fabric SY - Sinergy / Camira
Available colours 10



Fabric RM - Remix 3 / Kvadrat
Available colours 10

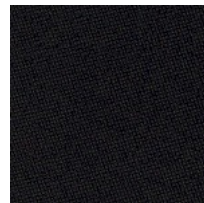

Fabric CH - Chili / Gabriel
Available colours 10



Fabric BN - Bondai / FiDiVi
Available colours 6



Fabric AB - Xtreme Plus / Camira
Available colours 6



Fabric FT - Foster / Vescom
Available colours 6

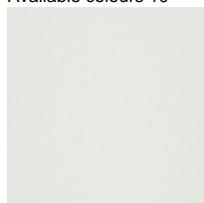

Fabric S1 - Steelcut 3 / Kvadrat
Available colours 2

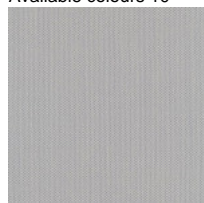

Fabric SE - Steelcut Trio 3 / Kvadrat
Available colours 6

Questo prodotto è garantito 5 anni. Sitland si riserva di apportare modifiche e/o migliorie di carattere tecnico ed estetico ai propri modelli e prodotti in qualsiasi momento e senza preavviso. Le foto e i colori visualizzati sono puramente indicativi e possono variare rispetto alla realtà. Per maggiori informazioni si prega di contattare il nostro Servizio Clienti service@sitland.com