

## Sit It



Sit.it, designed by Sergio Bellin and Dorigo Design, is a collection of managerial and executive seats with a structured linearity, with a steel and aluminium frame, offered in various fine upholsteries. An office classic, available in the executive, managerial and meeting versions, which affords impeccable comfort, thanks to the padded cushions, made with different densities. The stylish design of the armrests blends in seamlessly with the seat, characterising the entire collection.

## Projects

**Orgatec**, Colonia, Germania (2014)

## Executive

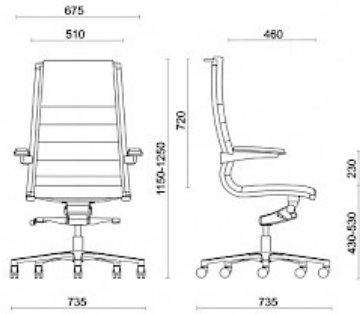

## Materials and colours

### Cushion (black supporting fabric)

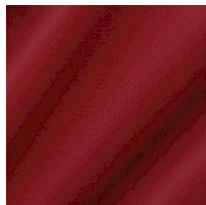

Faux leather CI  
Available colours 3

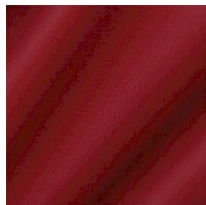

Faux leather CX  
Available colours 3



Leather TS  
Available colours 6

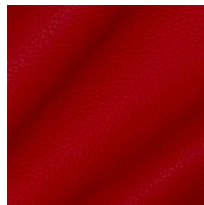

Leather S  
Available colours 4

### Cushion (white supporting fabric)

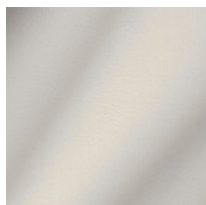

Faux leather CI  
Available colours 1

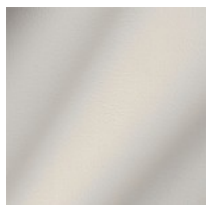

Faux leather CX  
Available colours 1



Leather TS  
Available colours 1

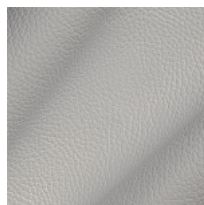

Leather S  
Available colours 1

### Cushion (brawn supporting fabric)



Leather TS  
Available colours 3

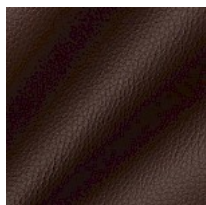

Leather S  
Available colours 3

### Cushion (taupe supporting fabric)

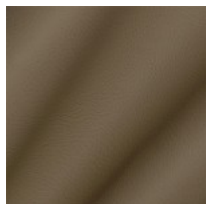

Faux leather CI  
Available colours 1

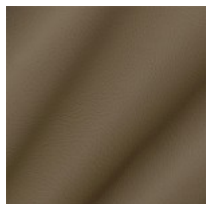

Faux leather CX  
Available colours 1



Leather TS  
Available colours 1

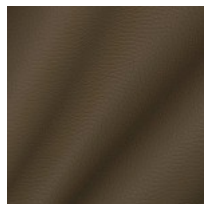

Leather S  
Available colours 1

**Questo prodotto è garantito 5 anni.** Sitland Spa si riserva di apportare modifiche e/o migliorie di carattere tecnico ed estetico ai propri modelli e prodotti in qualsiasi momento e senza preavviso. Le foto e i colori visualizzati sono puramente indicativi e possono variare rispetto alla realtà. Per maggiori informazioni si prega di contattare il nostro

Servizio Clienti [service@sitland.com](mailto:service@sitland.com)