

## Team Strike Evo



### Storie collegate

**M3 Mobili**, Città del Mexico, Messico (2023)

## Team Strike Evo Direzionale, struttura bianca

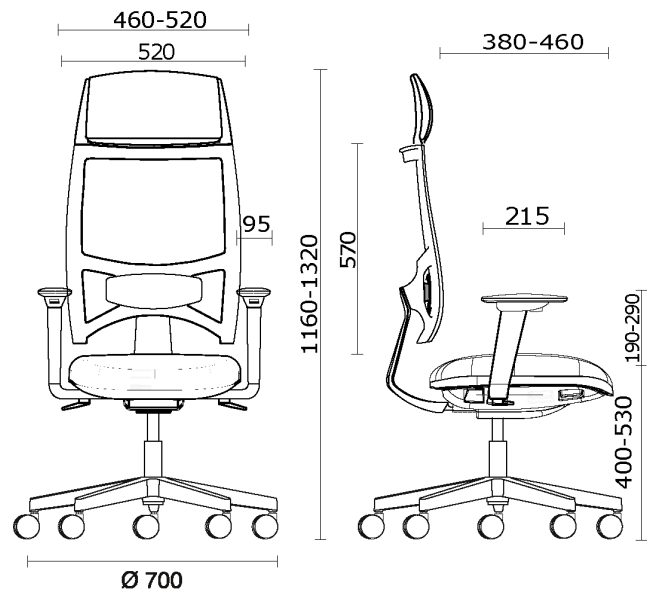

## Materiali e rivestimenti

### Rivestimenti schienale in rete



Rete RF - Polo / FiDiVi  
Service  
Colori disponibili: 5



Rete RR - Runner /  
Gabriel  
Colori disponibili: 10



Rete RY - Rhythm /  
Gabriel  
Colori disponibili: 6

### Rivestimenti sedile con schienale in rete

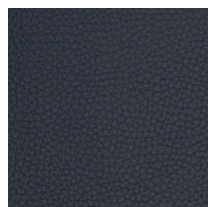

Tessuto spalmato NX  
Colori disponibili: 11

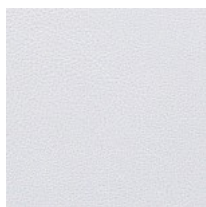

Tessuto spalmato SC -  
Secret / Flukso  
Colori disponibili: 10

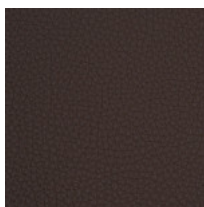

Tessuto spalmato NX  
Colori disponibili: 1



Pelle SX - Box Land /  
Dani  
Colori disponibili: 12



Tessuto AL - Alba /  
FiDiVi  
Colori disponibili: 10



Tessuto BN - Bondai /  
FiDiVi  
Colori disponibili: 10

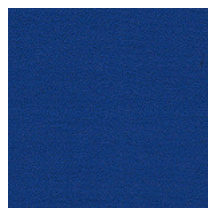

Tessuto AB - Xtreme  
Plus / Camira  
Colori disponibili: 10

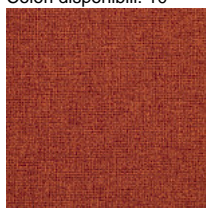

Tessuto ME - Medley /  
Gabriel  
Colori disponibili: 15



Tessuto MF - Main Line  
Flax / Camira  
Colori disponibili: 10

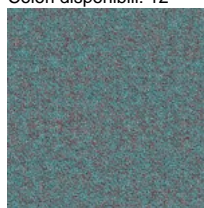

Tessuto SY - Sinergy /  
Camira  
Colori disponibili: 10

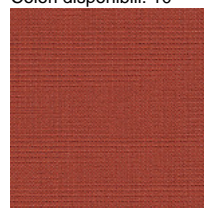

Tessuto CS - Crisp /  
Gabriel  
Colori disponibili: 10

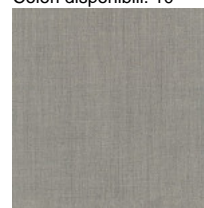

Tessuto RM - Remix 3 /  
Kvadrat  
Colori disponibili: 10

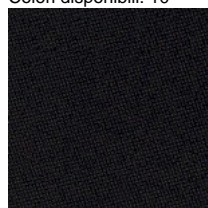

Tessuto CH - Chili /  
Gabriel  
Colori disponibili: 10

### Sedile e membrana schienale



Tessuto BN - Bondai /  
FiDiVi  
Colori disponibili: 10



Tessuto AB - Xtreme  
Plus / Camira  
Colori disponibili: 10



Tessuto ME - Medley /  
Gabriel  
Colori disponibili: 15

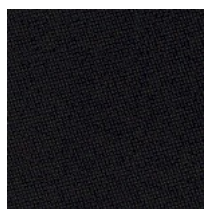

Tessuto CH - Chili /  
Gabriel  
Colori disponibili: 10



Tessuto CS - Crisp /  
Gabriel  
Colori disponibili: 10



Tessuto RM - Remix 3 /  
Kvadrat  
Colori disponibili: 10

**Questo prodotto è garantito 5 anni.** Sitland si riserva di apportare modifiche e/o migliorie di carattere tecnico ed estetico ai propri modelli e prodotti in qualsiasi momento e senza preavviso. Le foto e i colori visualizzati sono puramente indicativi e possono variare rispetto alla realtà. Per maggiori informazioni si prega di contattare il nostro Servizio Clienti [service@sitland.com](mailto:service@sitland.com)